

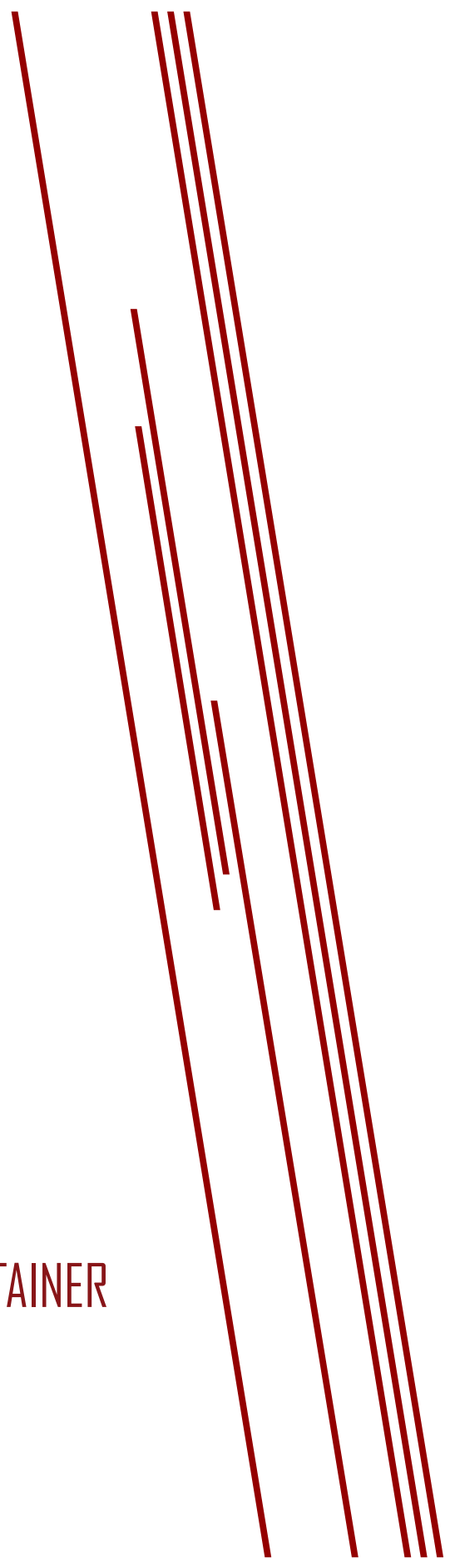

02 - ROLL CONTAINER



SOMMARIO DI SEZIONE

- 22 - NANO ROLL
- 23 - ACCESSORI NANO ROLL
- 24 - ROLL CONTAINER 2 SPONDE
- 25 - ROLL CONTAINER 3 SPONDE
- 26 - ROLL CONTAINER 4 SPONDE
- 27 - ACCESSORI ROLL CONTAINER
- 28 - ACCESSORI ROLL CONTAINER
- 29 - ROLL MAXI 3 SPONDE
- 30 - ROLL MAXI 4 SPONDE
- 31 - ACCESSORI ROLL MAXI
- 32 - ROLL LATTE
- 33 - ROLL CARICHI PESANTI

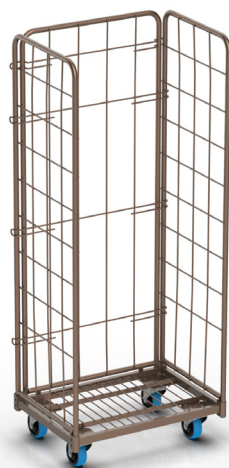

Codice	Descrizione	L (mm)	H (mm)	P (mm)	box	Pallet
ST-0027	Nano Roll	600	1600	400	-	-

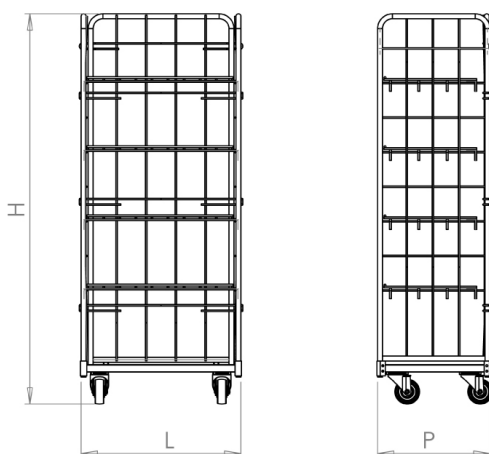

Accessori Nano Roll

art. ST-0028 - Piano in filo

Per maggiori informazioni visita il sito www.bmbproject.it

bmb
IDEE IN FILO

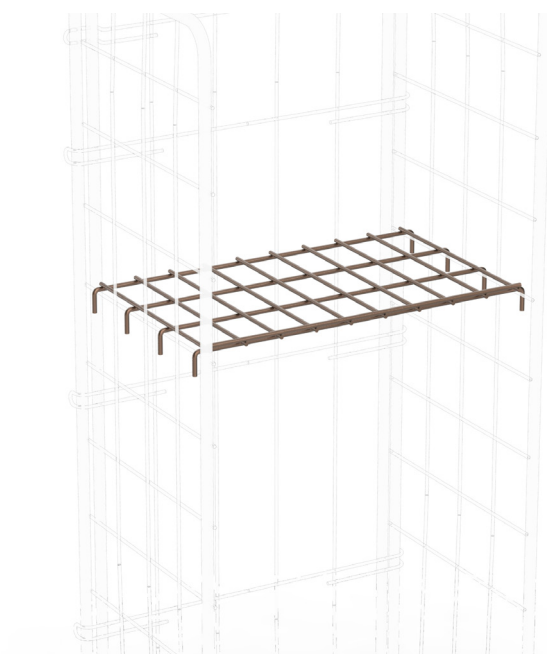

Codice	Descrizione	L (mm)	H (mm)	P (mm)	box	Pallet
ST-0028	Piano accessorio per Nano Roll	600	-	370	-	-

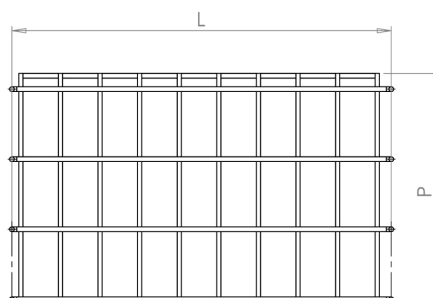



Codice	Descrizione	L (mm)	H (mm)	P (mm)	box	Pallet
ST061	Roll Container 2 sponde	805	1800	715	-	Sfuso/5Pz

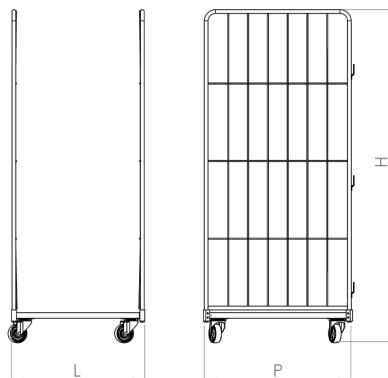

Roll Container 3 sponde

art. ST063

Per maggiori informazioni visita il sito www.bmbproject.it

bmb
IDEE IN FILO



Codice	Descrizione	L (mm)	H (mm)	P (mm)	box	Pallet
ST063	Roll Container 3 sponde	805	1800	715	-	Sfuso/5Pz

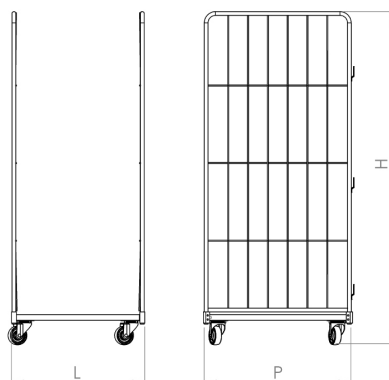



Codice	Descrizione	L (mm)	H (mm)	P (mm)	box	Pallet
ST060	Roll Container 4 sponde	805	1800	715	-	Sfuso/5Pz

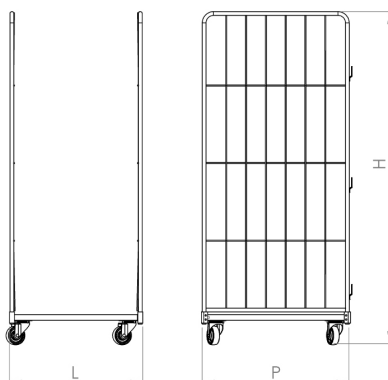

Accessori Roll Container

art. ST062 - Piano in filo

Per maggiori informazioni visita il sito www.bmbproject.it

bmb
IDEE IN FILO



Codice	Descrizione	L (mm)	H (mm)	P (mm)	box	Pallet
ST062	Piano Roll/Shelf	776		712	-	15 Pz

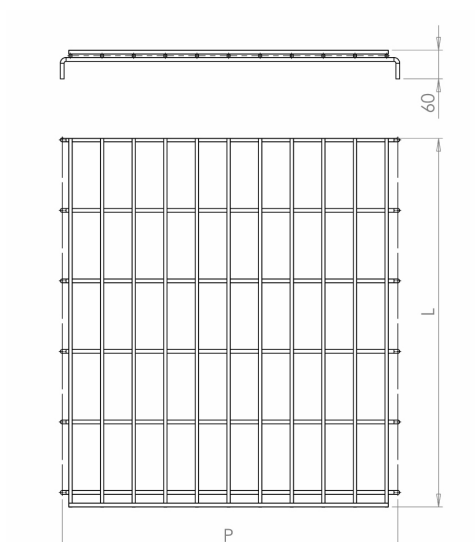



Codice	Descrizione	L (mm)	H (mm)	P (mm)	box	Pallet
ST074	Cinghie Chiusura				-	-

Roll Maxi 3 sponde

art. ST080 - Roll Maxi 1200x800

Per maggiori informazioni visita il sito www.bmbproject.it

bmb
IDEE IN FILO



Codice	Descrizione	L (mm)	H (mm)	P (mm)	box	Pallet
ST080	Roll Container 1200x800 3 sp.	1200	1800	800	-	-

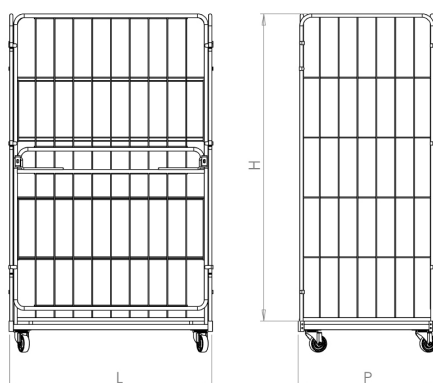



Codice	Descrizione	L (mm)	H (mm)	P (mm)	box	Pallet
ST300	Roll Container 1200x800 4 sp.	1200	1800	800	-	-

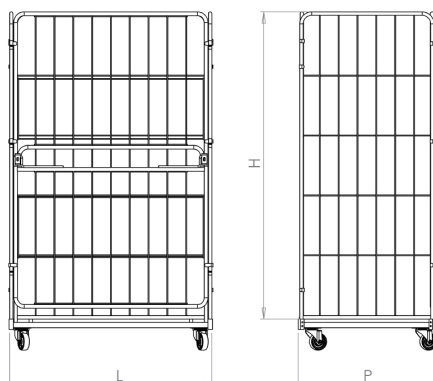

Accessori Roll Maxi

Ripiano Grigliato opzionale per Roll Maxi - art. ST081

Per maggiori informazioni visita il sito www.bmbproject.it

bmb
IDEE IN FILO



Codice	Descrizione	L (mm)	H (mm)	P (mm)	box	Pallet
ST081	Piano Grigliato per Roll Maxi	1170	-	736	-	-

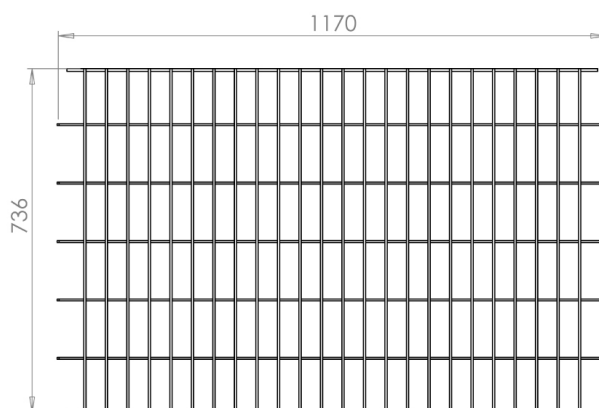



Codice	Descrizione	L (mm)	H (mm)	P (mm)	box	Pallet
ST065A4	Roll latte (fondo e 3 ripiani) LH 1000 x H 1800 x P 400	1000	1800	400	-	-
ST065A3	Roll latte (fondo e 3 ripiani) LH 450 x H 1800 x P 300	450	1800	300	-	-
ST065A2	Roll latte (fondo e 3 ripiani) LH 500 x H 1800 x P 400	500	1800	400	-	-
ST065A1	Roll latte (fondo e 3 ripiani) LH 600 x H 1800 x P 400	600	1800	400	-	-

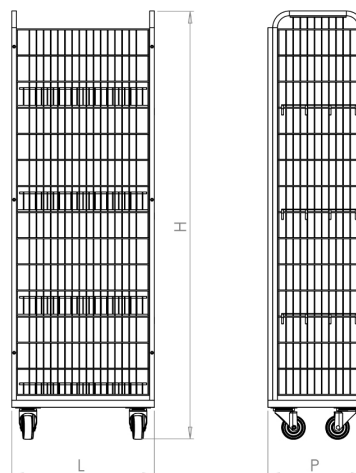

Roll Carichi Pesanti

art. ST080-1 - Roll carichi pesanti

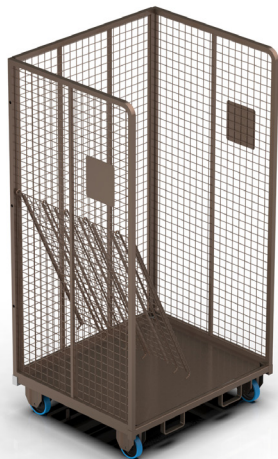

Codice	Descrizione	L (mm)	H (mm)	P (mm)	box	Pallet
ST080-1	Roll Container Carichi pesanti	1200	2000	800	-	-

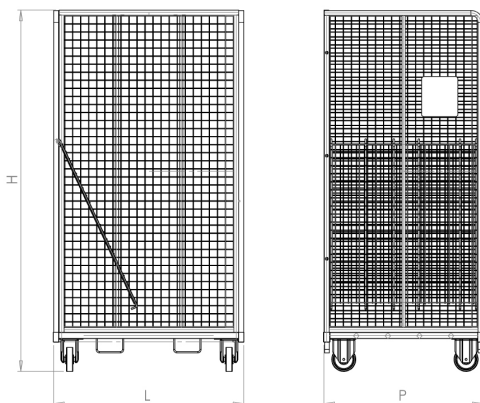



BMB S.r.l.
via Ubrico, 27/A
63842 Monsampietro Morico (FM)
Phone: +39 0734 773411
commerciale@bmbproject.it
roncaglia.matteo@gmail.com
www.bmbproject.it

